

Article number: 2310431079S

Description: E+G Levelling elements
LX.30-SW17-M10X73-S

Measures

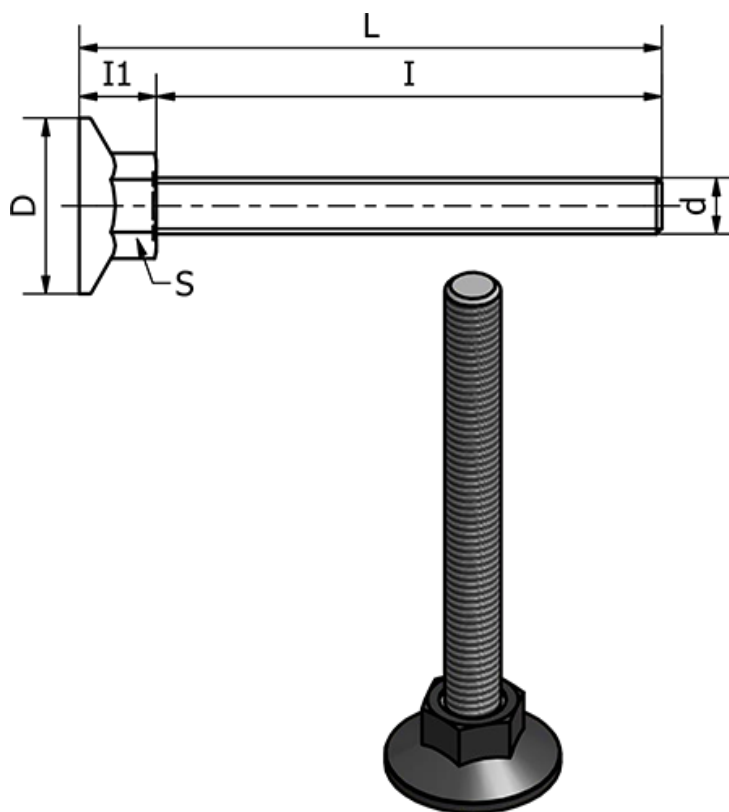

d	= M10
D	= 30
I	= 73
I1	= 12
L	= 85
S	= 17
Static load in (N)	= 3000
Type	= Forzinket

Weight (g) = -